

丈量図

S=1:500

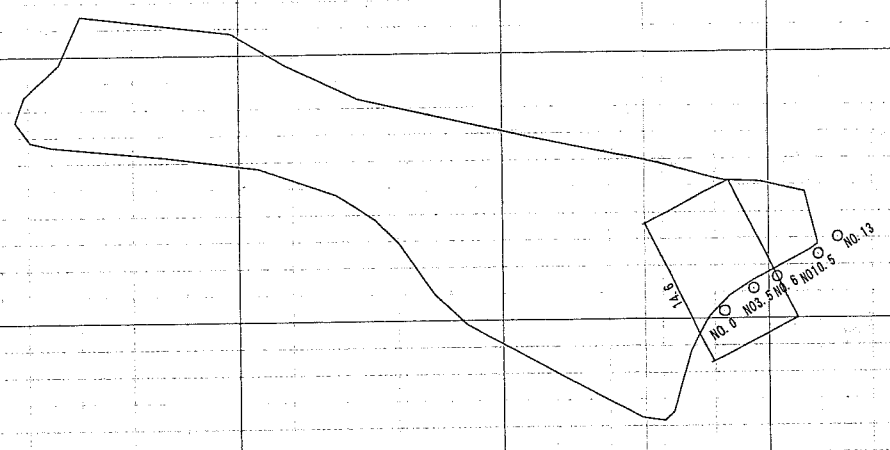

傾斜度算出表		
14.6		
H/L=3.5/14.5=0.2414→13°		
面積測定表		
測定方法	CADソフトによる	
測定値	1064.2	m ²
1回目	1064.2	m ²
2回目	1064.2	m ²
3回目	1064.2	m ²
面積平均	10.64	a

横断面図

S=1:100

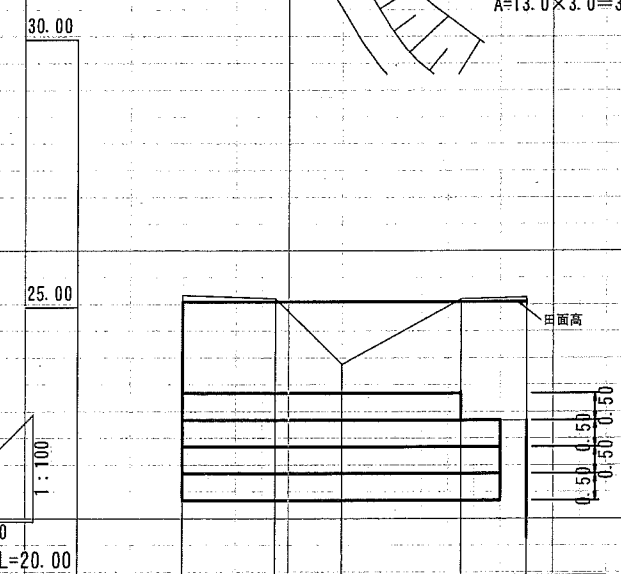

勾配	配盛	計画高	地盤高	追加距離	単距離	測点
			25.23	0.00	0.00	NO.0
			25.17	3.50	3.50	NO.3.5
			23.94	6.00	2.50	NO.6
			25.16	10.50	4.50	NO.10.5
			25.19	13.00	2.50	NO.13
			25.11			田

植生工展開図

S=1:100

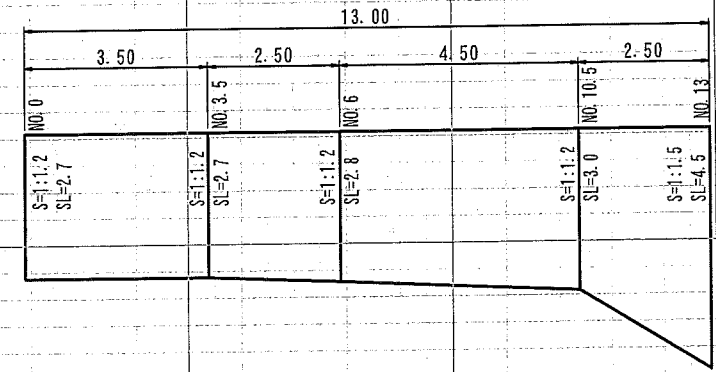

フトン管配置図

S=1:100

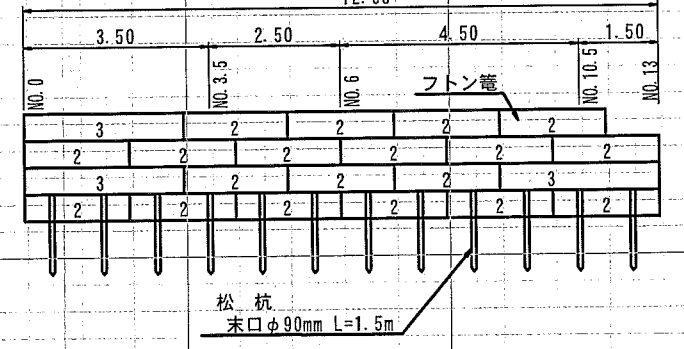

フトン管詳細図

S=1:50

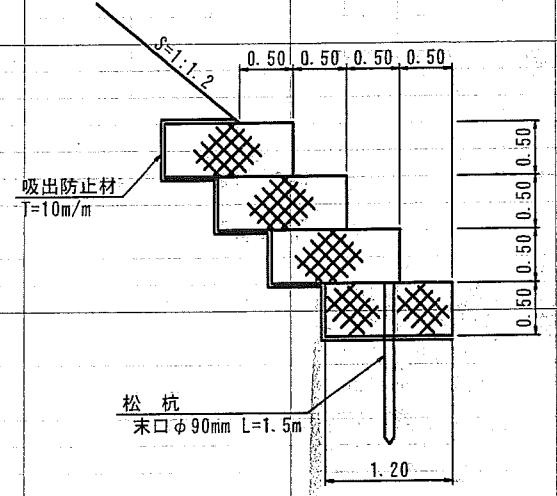

畦畔工

S=1:40

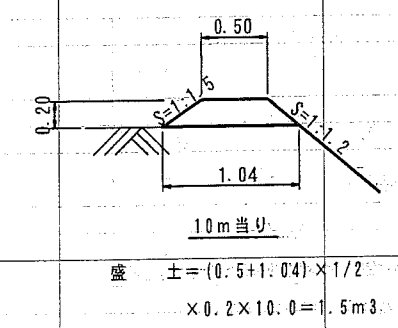

仮設道路

S=1:100

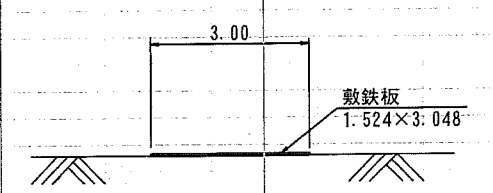

掘削 = $(4.1+1.8) \times 1/2 \times 3.5 + (1.8+1.6) \times 1/2 \times 2.5 + (1.6+1.8) \times 1/2 \times 4.5 + (1.8+3.8) \times 1/2 \times 2.5 = 29.2 \text{ m}^3$
 崩土 = $(0.5+2.3) \times 1/2 \times 3.5 + (2.3+3.3) \times 1/2 \times 2.5 + (3.3+5.8) \times 1/2 \times 4.5 + (5.8+0.1) \times 1/2 \times 2.5 = 39.8 \text{ m}^3$
 盛土 = $(1.7+2.2) \times 1/2 \times 3.5 + (2.2+3.2) \times 1/2 \times 2.5 + (3.2+3.8) \times 1/2 \times 4.5 + (3.8+2.2) \times 1/2 \times 2.5 = 36.8 \text{ m}^3$
 床掘 = $0.6 \times 13.0 = 7.8 \text{ m}^3$
 埋戻 = $(0.9+1.3) \times 1/2 \times 3.5 + (1.3+1.7) \times 1/2 \times 2.5 + (1.7+1.5) \times 1/2 \times 4.5 + (1.5+0.7) \times 1/2 \times 2.5 = 17.6 \text{ m}^3$
 残土処理 = $29.2 + 39.8 + 0.9 + 7.8 - (36.8 + 17.6 + 1.1) \div 0.9 = 11.2 \text{ m}^3$
 フトン管 $(2.0 \times 1.2 \times 0.5) \times 13 = 38.0 \text{ m}^3$
 振芝 = $(2.7+2.7) \times 1/2 \times 3.5 + (2.7+2.8) \times 1/2 \times 2.5 + (2.8+3.0) \times 1/2 \times 4.5 + (3.0+4.5) \times 1/2 \times 2.5 = 9.0 \text{ m}^2$
 畦畔工 = 38.8 m^2
 畦畔工 = 7.0 m^2
 畦畔工 = $7.0 \times 1.5 / 10.0 = 1.1 \text{ m}^3$

実施

図面の名称	図面名称
平成28年災第 23 / 79号	1 / 2
田 災害復旧工事	
大田市久利町久利	
受益者代表	

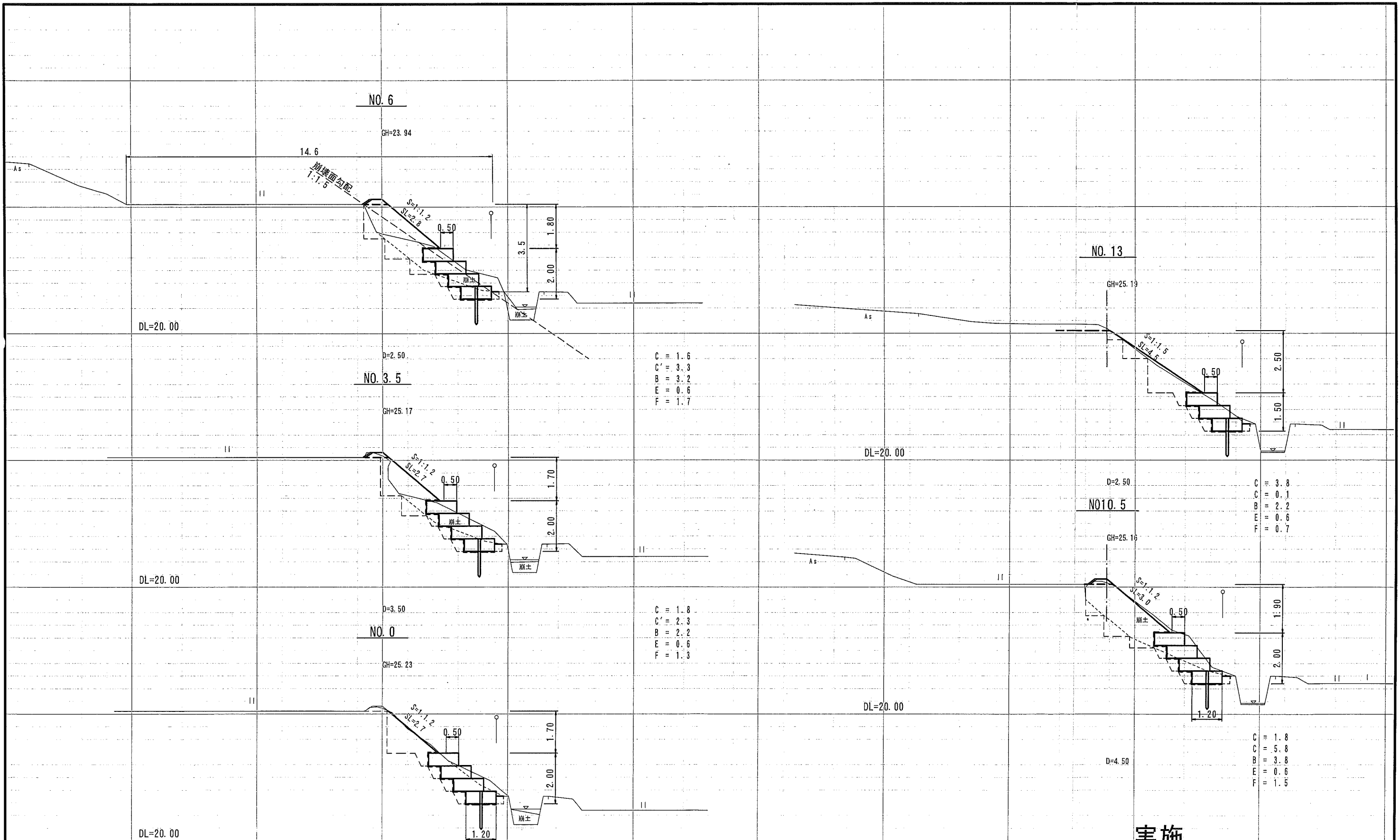

C = 1.6
 C' = 3.3
 B = 3.2
 E = 0.6
 F = 1.7

C = 1.8
 C' = 2.3
 B = 2.2
 E = 0.6
 F = 1.3

C = 4.1
 C' = 0.5
 B = 1.7
 E = 0.6
 F = 0.9

C = 3.8
 C' = 0.1
 B = 2.2
 E = 0.6
 F = 0.7

C = 1.8
 C' = 5.8
 B = 3.8
 E = 0.6
 F = 1.5

実施

凡 例

C	=	掘削
C'	=	崩土
B	=	盛土
E	=	床掘戻
F	=	埋戻

図面の名称		図面名称
平成28年災第 23 / 79号		
田 災害復旧工事		2 / 2
大田市久利町久利		
受益者代表		